

## NAREDI PAPIRNATO LETALO

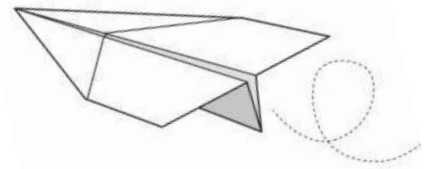

**Izdelovanje papirnatega letala je prav tako zabavno kot igranje z njim, in to ne glede na to, ali si v družbi ali ne. Ko enkrat obvladaš osnovno obliko, lahko letalu dodaš zavihke na repu, zaradi česar bo letelo levo ali desno.**

- 1) Najprej papir prepogni po dolžini. Nato ga razpri in prepogni zgornja robova proti sredini, da nastane trikotnik.
- 2) Zavihka še enkrat prepogni navznoter. Poskrbi, da bodo spodnji robovi čim bolj enakomerni.
- 3) Letalo pri konici zapogni navzdol, nato pa prepogni še po sredini. Na koncu mu zapogni še krila ter ga razpri.

**Tekmujte, kdo ga lahko vrže najdlje!**

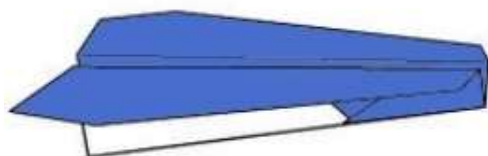
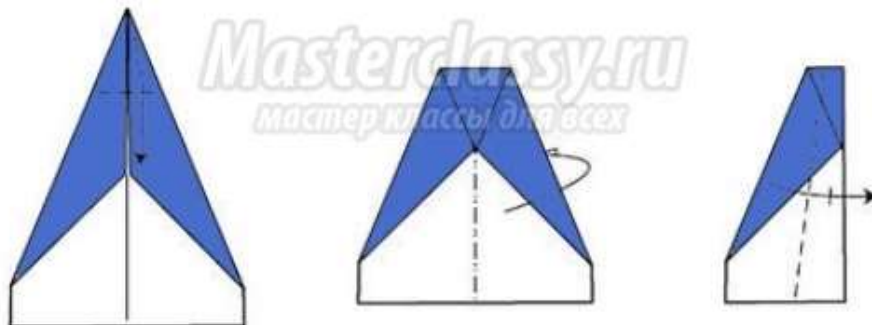
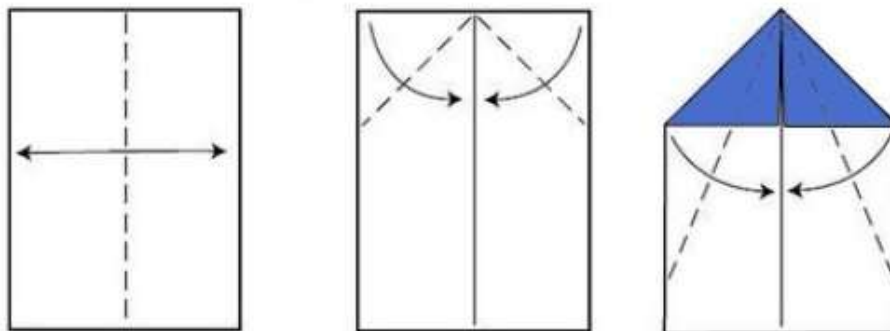

## ŠE NEKAJ OSTALIH IDEJ ZA IZDELOVANJE RAZLIČNIH LETAL

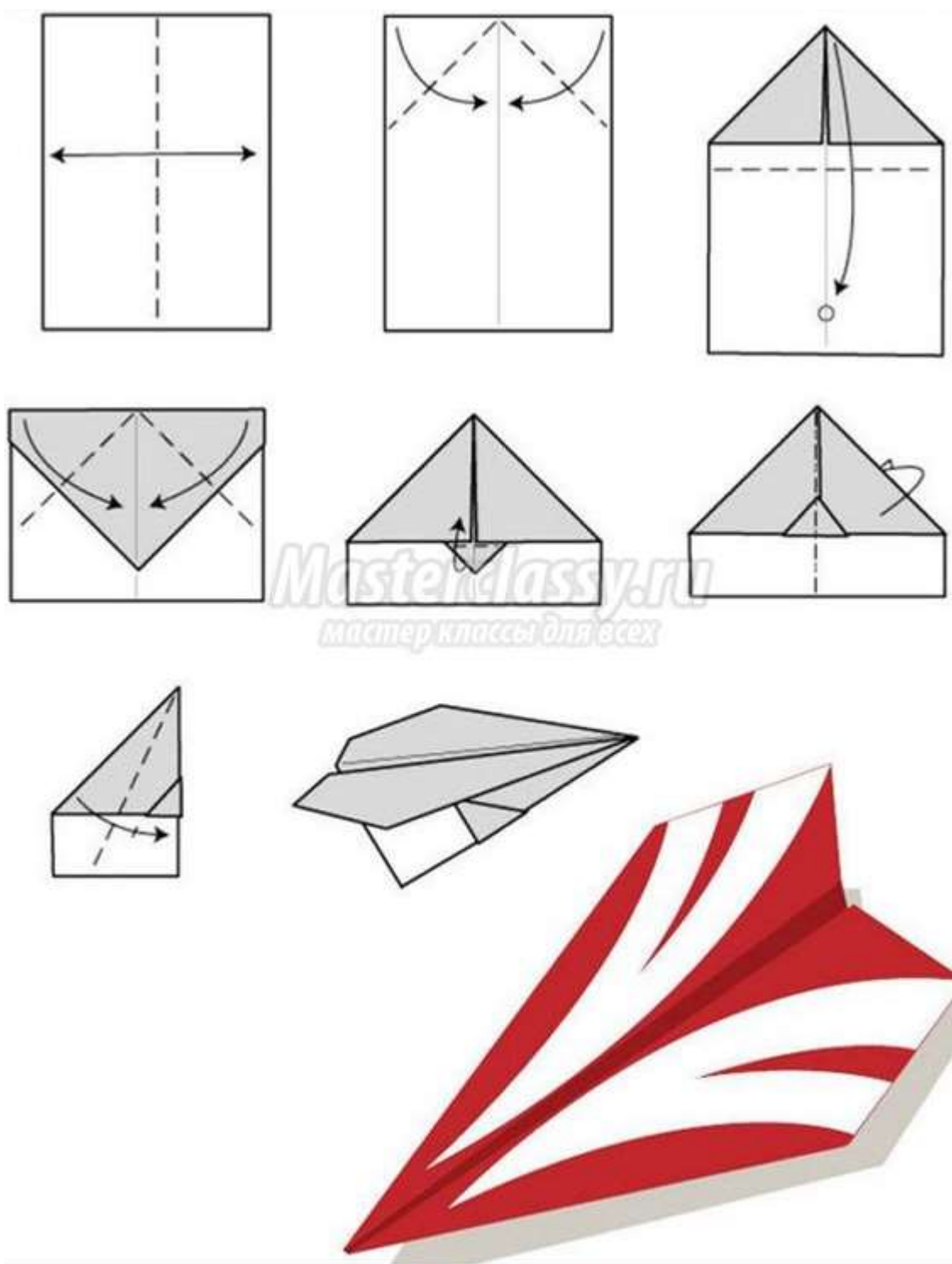

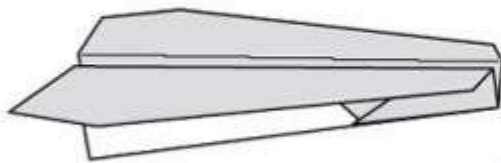
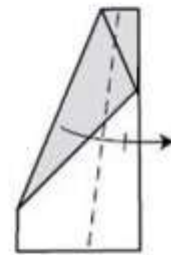
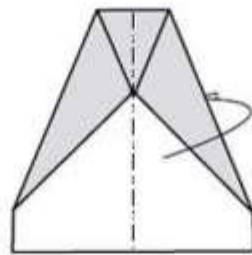
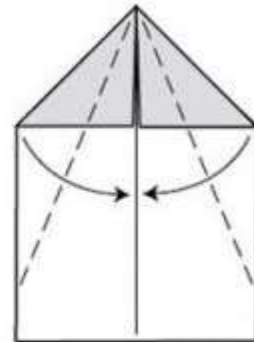
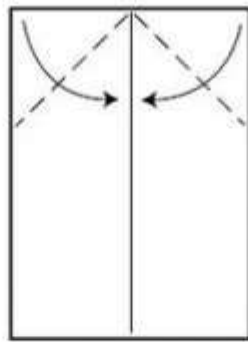
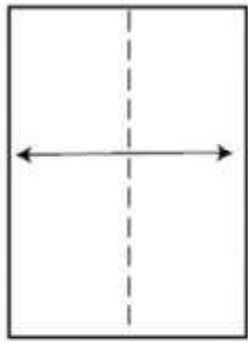

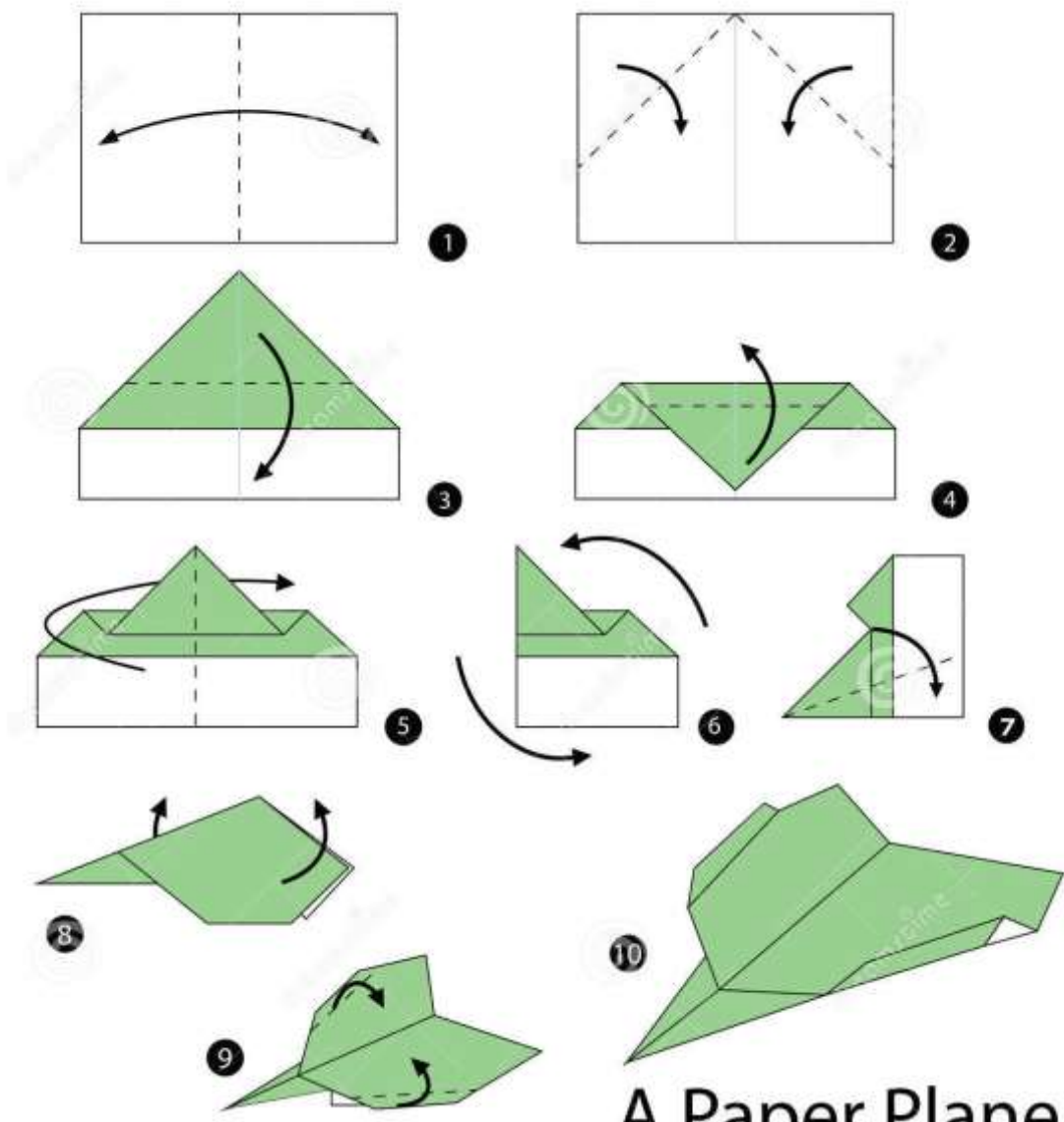

A Paper Plane